

Modulate™ Curved 824

MOD-C-824

Modulate™ consists of a set of frames made from aluminium tubes (Ø30 mm) covered with a printed tension fabric graphic. These frames can be connected together using powerful magnets inside each frame. Modulate range is available in 11 different sized formats.

- Thanks to the exclusive **MagLink** magnetic system built into the structure, you can connect the frames by simply touching them together.
- With the **Twist & Lock** system, simply position the foot under the structure, turn it and it's locked!
- The graphics are very easy to maintain thanks to the crease-resistant and machine washable textile cover. Stretch fabric with zip system.

	360° MagLink connector in each pole. 4 magnets per structure		400 mm extension included
	Self-locking system with bungee poles and push-buttons		Simple assembly with numbered frame parts
	Central reinforcement tube (Ø 18 mm)		2 stabilising feet with Twist & Lock supplied with each frame
	Double-sided tension fabric. Zip system		Modulate™ carry bag with dedicated compartments for the feet and graphics

Structure informations :	
Item	Modulate Curved 824
Code	MOD-C-824
Structure dimensions	948 (w) x 2400 (h) x 372 (d) mm
Graphic visual area	895 (w) x 2382 (h) mm
Boxed dimensions (2 boxes)	1000 (w) x 245 (h) x 125 (d) + 460 (w) x 65 (h) x 65 (d) mm
Structure weight	6.93 kg
Boxed weight (2 boxes)	7.27 kg

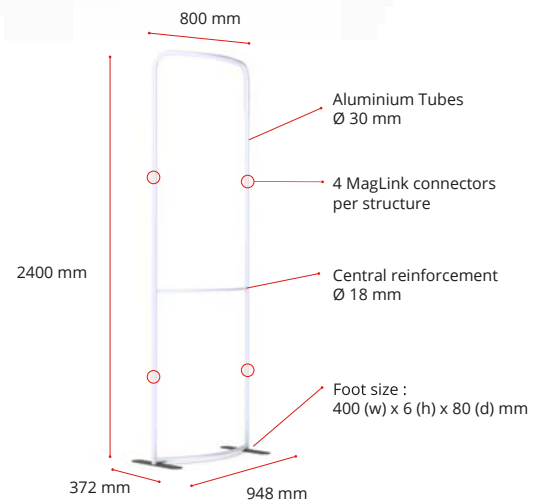
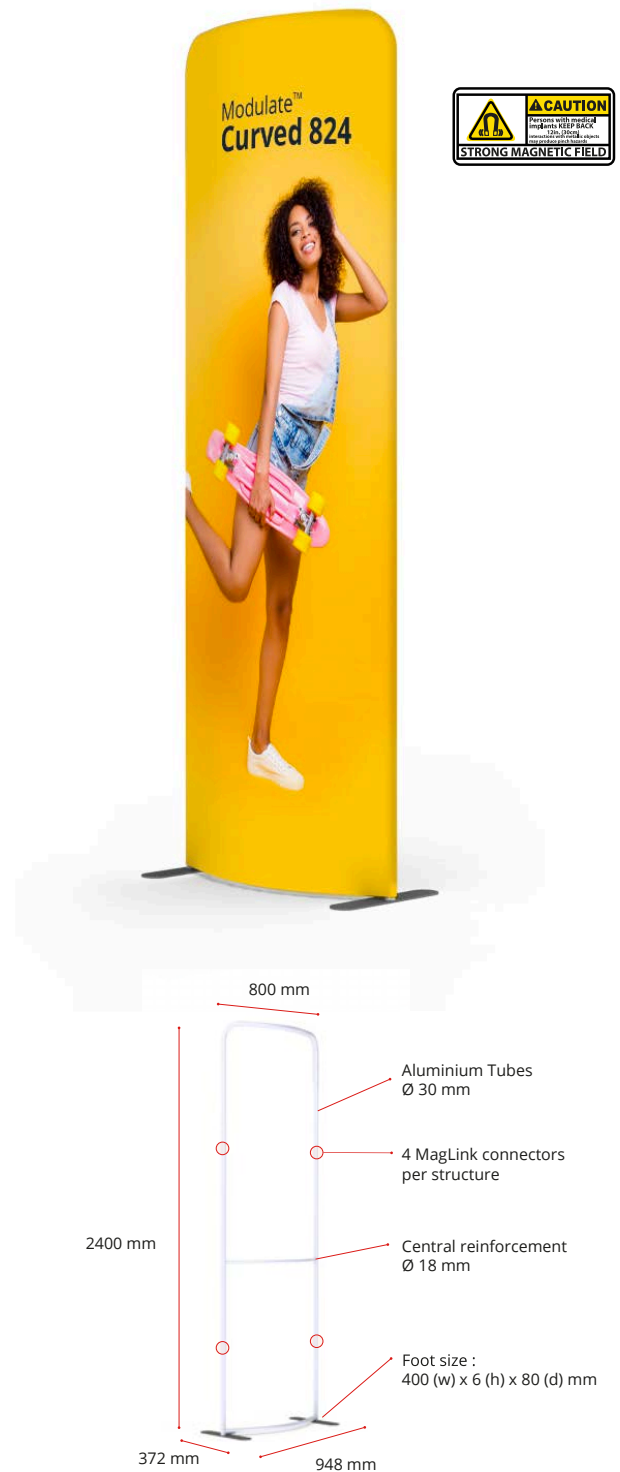

OPTIONAL ELEMENTS :

Modulate half feet (pair) MOD-HALF-FOOT-P 218 (w) x 6 (h) x 80 (d) mm	Spot LED Flood LED-FLOOD-ARM-BDLK	Spot LED Strip LED-STRIP-ARM-BDLK	Fixing for 30mm Ø tubing US903

MIX & MATCH THE 11 MODULATE FRAMES :



Modulate™ Curved 824

MOD-C-824

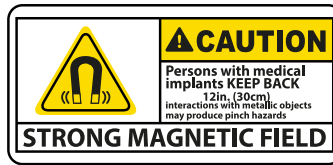

ELEMENTS

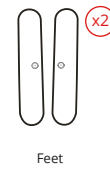
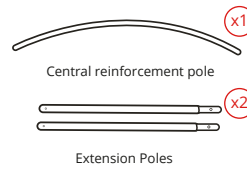
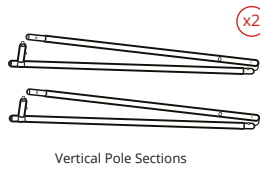
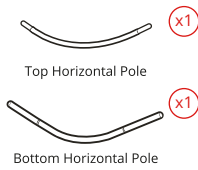
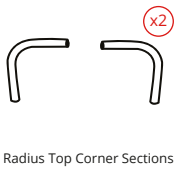

ASSEMBLY

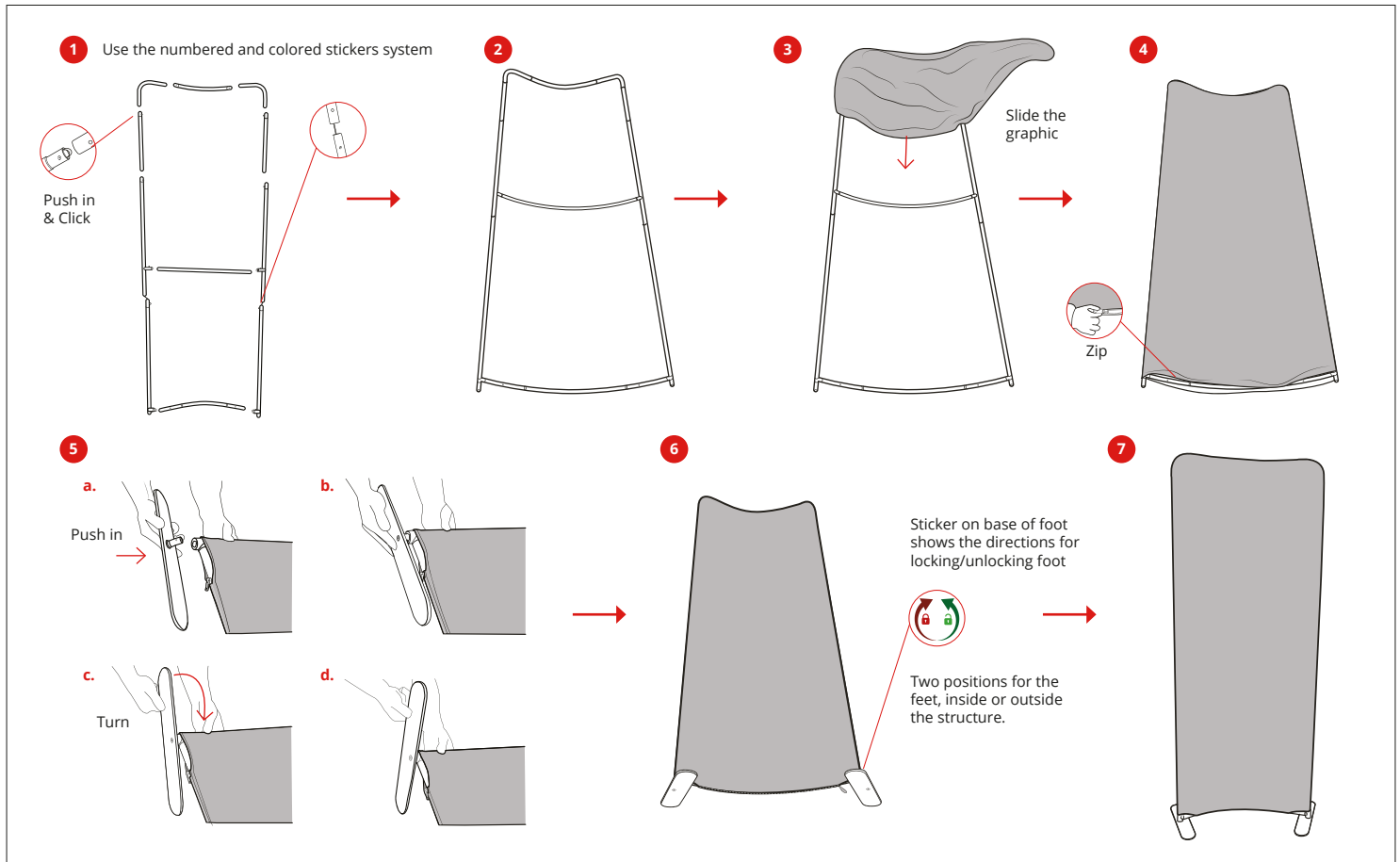

REKONFIGURIERBARE HÖHE

2400 MM → 2000 MM

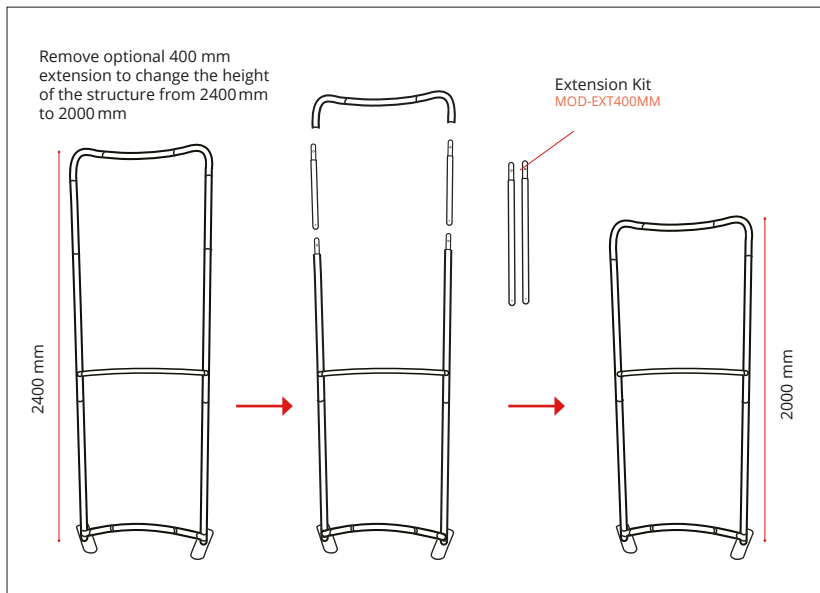

CONNECTING MULTIPLE FRAMES

Remove one foot from second frame and align both frames on one foot

