

Stackable Water Base

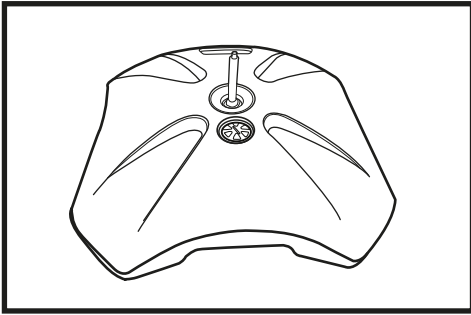

PARTS (NOT TO SCALE)

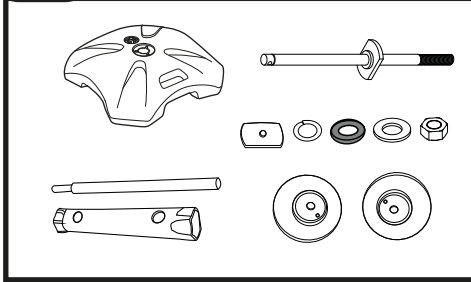

ASSEMBLY OF BOX SPANNER

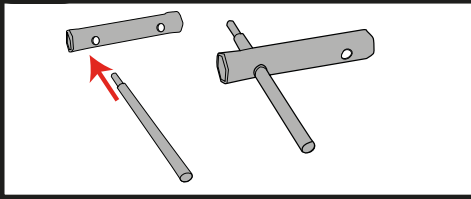

TOOLS REQUIRED

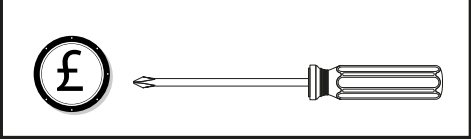

FOR ATTENTION

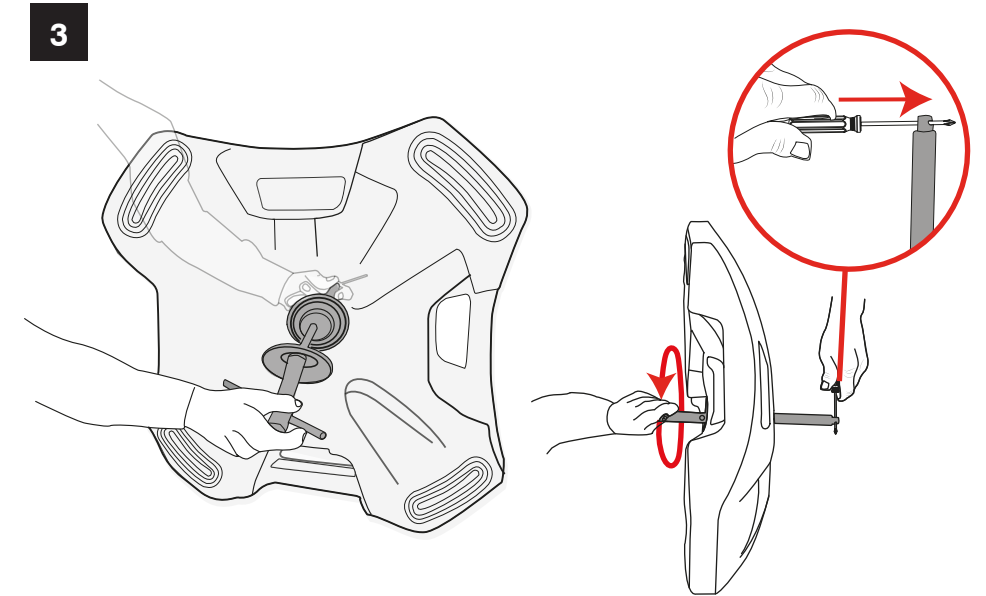
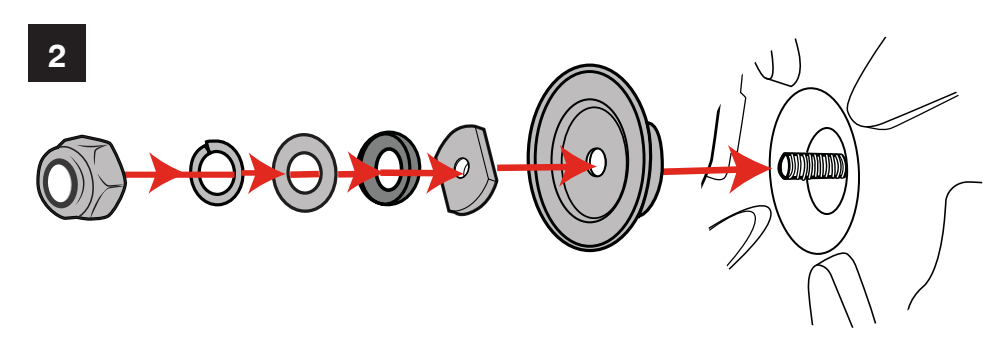
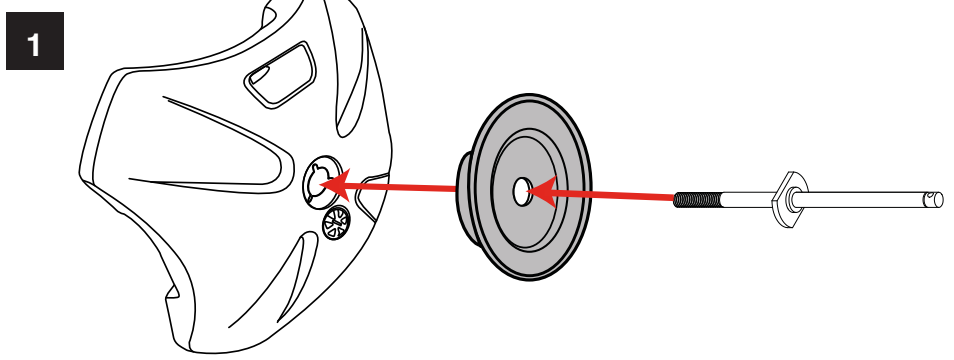
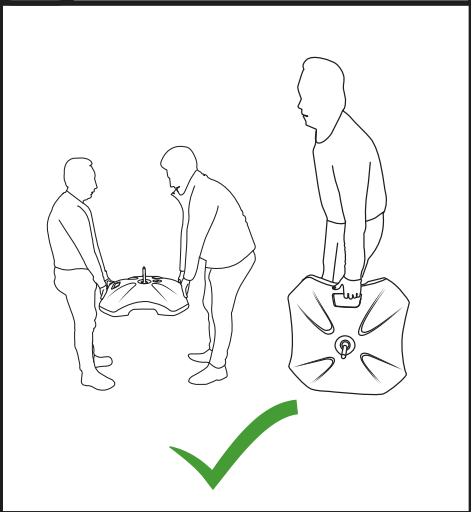

NOTE: USE SCREWDRIVER AND BOX SPANNER TO TIGHTEN SPIGOT

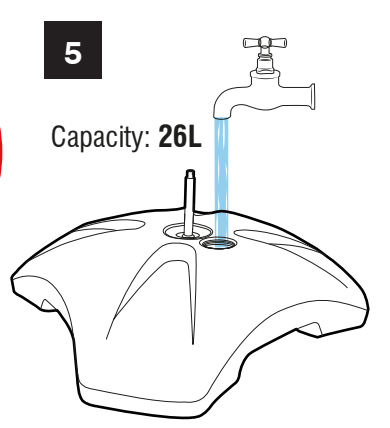
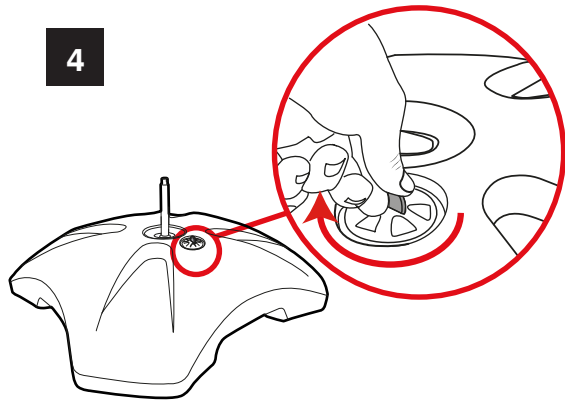

6

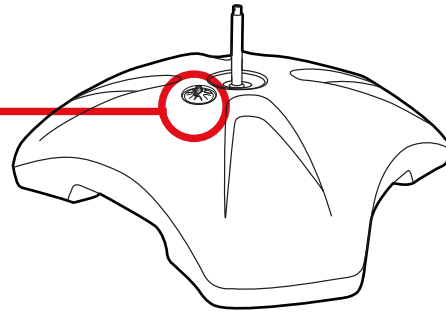
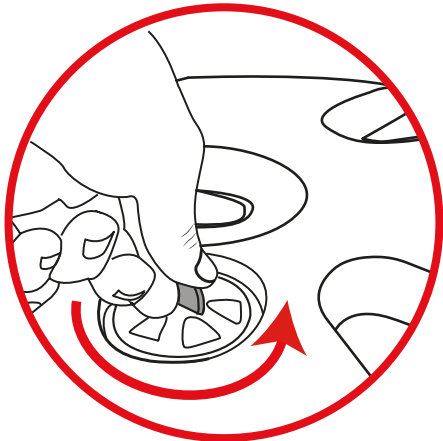

NOTE: TIGHTEN WITH A COIN



STACKING THE BASES

7

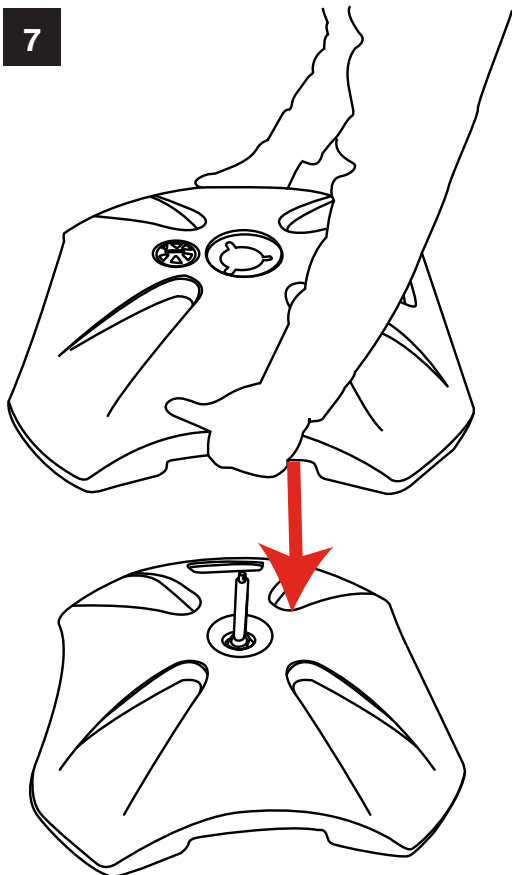

8

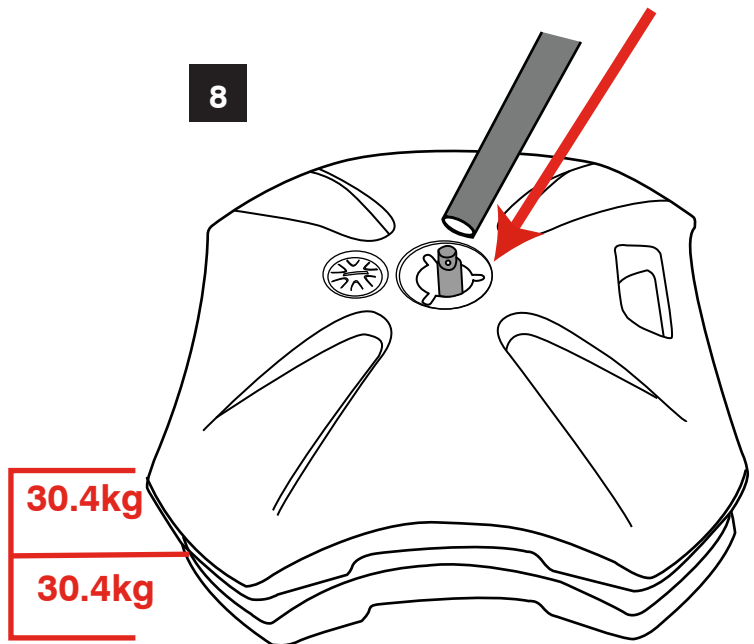

30.4kg

30.4kg

TOTAL WEIGHT UP TO 60.8KG